

Overview of JEM-EF on ISS

Kazuyoshi Kawasaki¹
¹Space Environment Utilization Center
TKSC, Tsukuba, Ibaraki, Japan
E-mail (KK): Kawasaki.kazuyoshi@jaxa.jp

ABSTRACT

Japanese Experiment Module “Kibo” Exposed Facility (JEM-EF) is a multipurpose experiment platform where various activities such as scientific experiments, Earth observation, engineering experiments. Those can be conducted by utilizing environment which is exposed to space characterized with microgravity, high level vacuum and vast area. MAXI will be attached to the JEM-EF ram side port (EFU#1). On ISS, JEM-EF and the Truss sites are the main facilities that allow experiments those being exposed to space environment, which many researchers are interested in. JEM-EF will be launched by STS-127(2J/A) flight in May, 2009.

The JEM-EF with its size of 6m x 5m x 4m (20ft x 16.7ft x 13.3ft) weighs approximately 4000kg (8890lb) at time of launch. Experiment payloads of JEM-EF can be exchanged by Kibo robotics arm. JEM-EF will be operated for ten years on orbit supporting exposed experiments. It will supply electric power, circulates coolant for cooling the experiment devices or collects experiment data. Standard payload envelope is assumed to be of 1.85m x 1.0m x 0.8m (6.2ft x 3.3ft x 2.7ft) and weighs 500kg (1110lb). In this paper, further detail of the JEM-EF will be presented.

1. General

The ISS (International Space Station) program has started since the middle of 1980's to build a lasting manned facility that enables various activities in the space environment.

Japan, one of major participating nations to the ISS program, will provide a space science laboratory, Japanese Experiment Module, “KIBO”, aiming for implementing a wide variety of space researches on the ISS.

KIBO is composed of several modules, and the JEM-EF (Exposed Facility), one of important and unique KIBO hardware, can serve scientists, engineers, etc. with fields of experiments in the environment which is directly exposed to the space.

JEM-EF will be launched by STS-127(2J/A) flight in May, 2009.

2. JEM-EF System Characteristics

The EF is attached to the JEM-PM (KIBO Pressurized Module) via BM (Berthing Mechanism) and can accommodate other hardware such as MAXI, ICS-EF (Inter orbit Communication System - EF), ELM-ES (Experiment Logistics Module - External Section), and HTV-EP (H2A Transfer Vehicle - Exposed Pallet).

The EF receives several resources (electrical power, coolant, etc.) through the JEM-PM's BM and distributes them to the attached EF P/Ls (Payloads) for experiments. These EF P/Ls will be transported by ELM-ES (Space shuttle carrier) or HTV-EP (H2A Transfer Vehicle carrier) and will be attached to the EF port via EEU (Equipment Exchange Unit) using JEM RMS (JEM Remote Manipulator System).

By exchanging the P/L, various experiments will be possible on the EF during its operational life.

The main characteristics of the JEM-EF are:

- Dimensions : Approx. 5.7m × 5.0m × 3.8m
- Launch Max. Weight : 4038 kg (8902 lbs)
[Actual measurement: 3951 kg (8711 lbs)]
- On Orbit Max. Weight : 13538 kg (29846 lbs), including 9500 kg (20944 lbs) of P/L, etc.
- Operational Life : 10 years
- Performance :
 - a. Power Consumption - 562.6W
for housekeeping
/payload support on orbit
 - b. Max. Power Usage - 11kW
(System: 1kW, P/L: 10kW)

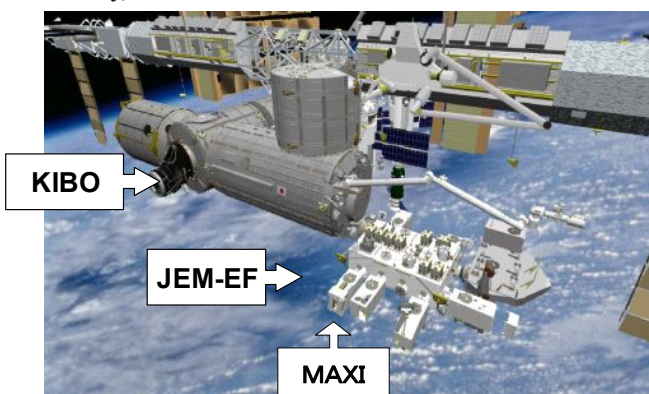

Fig.1. “KIBO” (JEM) Exposed Facility

c. C&DH (Communication & Data Handling)

- System Local bus-2
- Payload bus-2:
 - Primary & second 1ea for P/Ls
- High rate data: Total 8ch for P/Ls
- Video data: 2ch for EF system(external video camera) & 2ch for P/Ls
- Ethernet: Total 7ch for P/Ls
- Local bus P/L JEM(NASA P/L bus):
 - Prim. /second. 1ea for P/Ls

d. TCS

- Max. Heat Transfer: 11kW
- Fluid Temperature: nominal 16-24°C
- Max. Design Pressure: 12kgf/cm² (1.18MPa / 171psi)
- Flow Rate: Max.1940kg/Hr
- Coolant: Fluorinert-72 (Perfluoro carbon)

e. Berthing Capability

- P/L: max.12 locations (EFU1-12) (max.10 simultaneous ops)
- ICS-EF: 2 locations (EFU7/nominal, EFU5/backup)
- ELM-ES: 2 locations (EFU10/nominal, EFU9/backup)
- HTV-EP: 2 locations (EFU10/nominal, EFU9/backup)

3. EF Subsystem Functions

The JEM-EF system consists of several subsystems such as EPS (Electrical Power System), C&DH (Communication & Data Handling), TCS (Thermal Control System), etc., and these subsystem components are replaceable as ORU (Orbital Replaceable Unit) such as R-ORU (Robotics compatible), E-ORU (EVA compatible), or other common/unique ORUs. If these subsystem components failed, they can be replaced by JEMRMS with SFA (Small Fine Arm) or EVA (Extravehicular Activity) on orbit.

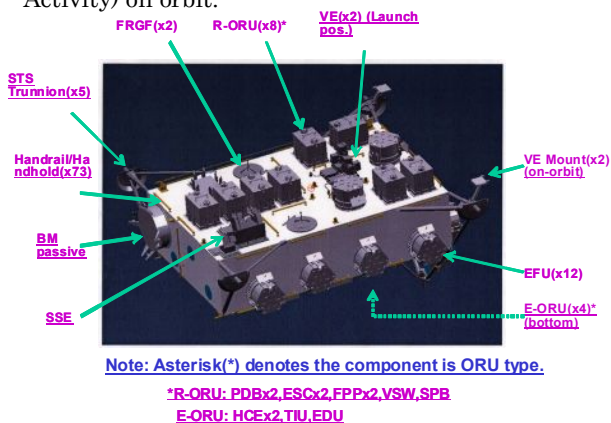

Fig.2 JEM-EF Subsystems

The JEM-EF's TCS consists of Active TCS and Passive TCS. As ATCS, there is a fluid loop system to absorb the heat, and as PTCS there are heaters, insulators, etc. to maintain the thermal condition of the JEM-EF components.

Fig.3 shows the JEM-EF fluid loop system in ATCS. The JEM-EF ATCS has:

- 2 Pumps (FPP, 1 for redundant)
- 2 Accumulators (1 for redundant)
- Flow rate control by differential pressure sensor feedback.
- Heat rejection by EF Heat Exchanger (EFHX) located outside on the JEM-PM.
- Valves that have a back pressure relief mechanisms for pressure release from the payload section when its pressure increased too high.

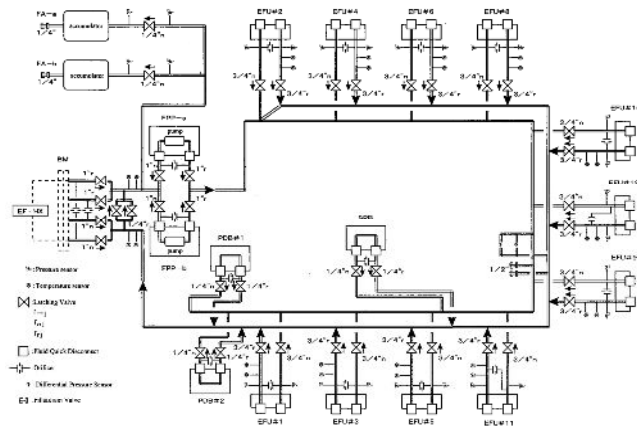

Fig.3 JEM-EF ATCS loop schematics

4. Payload Resources/Interface

4.1 Resources

The JEM-EF has 12 attachment ports for external payload and can accommodate up to 10 payloads simultaneously. Japan and U.S. shares these ports (5 for Japan, and 5 for U.S.).

Fig.4 shows the port locations and its number. Each port can accommodate 500kg class payload while the port #2, #9 and #10 can accommodate up to 2,500kg class payload. The experimental power is 3 kW (120Vdc) maximum while the port #1 and #2 has two power lines (3kW x 2). For data communication, there are Payload Bus (1553B), Ethernet, and High rate data link. The accommodation varies at each port location. The Table 1 shows the payload resources in detail.

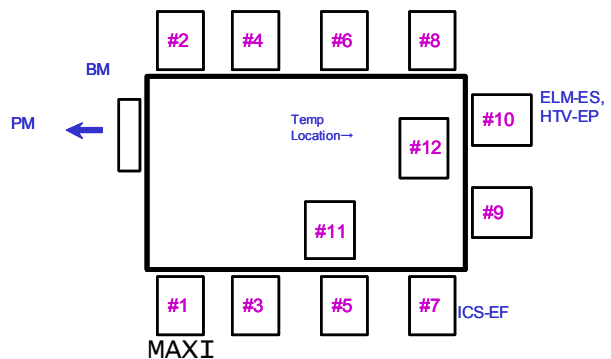

Fig.4 JEM-EF Port location for external payloads

Table 1 Payload resources

EFU #	USAGE	Max P/L Weight (kg)	POWER		Payload BUS	NASA local BUS	VIDEO data x3	C&DH High rate data	Ethernet	HK data	JCS local BUS2	System local BUS2	TCS 3kW Coolant
			3kW	100W									
1	U	500	2	1R	1R	1	1	1	1	2R			1 (6kW)
2	U	2500	2	1R	1R	1	1	1	1	2R			1 (6kW)
3	U	500	1	1R	1R	1	1	1	1	2R			1
4	U	500	1	1R	1R	1	1	1	1	2R			1
5	U/JCS backup	500	1	1R	1R	1	1	1	1	2R	1R		1
6	U	500	1	1R	1R	1	1	1	1	2R			1
7	S/JCS	500	1	1R	1R	1	1	1	1	2R	1R		1
8	U	500	1	1R	1R	1	1	1	1	2R			1
9	U/ES/EP backup	2500	1	1R	1R	1	1	1	1	2R		1R	1
10	S/ES/EP	2500	1	1R	1R	1	1	1	1	2R		1R	1
11	U	500	1	1R	1R	1	1	1	1	2R			1
12	U/S(P/L temp)	1350	1	1R	1R	1	1	1	1	2R			1

Usage: U(User), S(System)
 1R: Single Redundancy 2R: Double Redundancy
 Power(*1): Power supply is selected from either for EFU#2(one line,3kW) or EFU#12.
 (*2): EFU#7 has 0.6kW power line.
 Video(*3): 1ch is selected among EFU#1,#4,#5, and #8, and 1 more ch is selected among EFU#2#3#6, and #9.
 HK: House Keeping=Temperature/Pressure

4.2 Interface

The attachment port on the JEM-EP has mechanical, thermal and electrical interface with attached payloads. This interface mechanism is called Experimental Exchange Unit (EEU). Fig. 4 shows the EEU. The EEU consist of two parts, one is Exposed Facility Unit (EFU) on the JEM-EP side, and the other is Payload Interface Unit (PIU) on the payload side. The EFU has an active mechanism which grapples and fixes the payload. The PIU is a passive half to be grappled by three EFU latching arms. The mechanism is designed to connect the Quick Disconnect (QD) for ATCS fluid and electrical lines securely and safely.

The PIU is a Government Furnished Equipment (GFE) and is provided to the payload developers. In addition to the PIU, the external payload must equip a FRGF (interface with Robotics Arm) and an interface with the launch carrier. Fig. 5 shows these interfaces on the MAXI, for example.

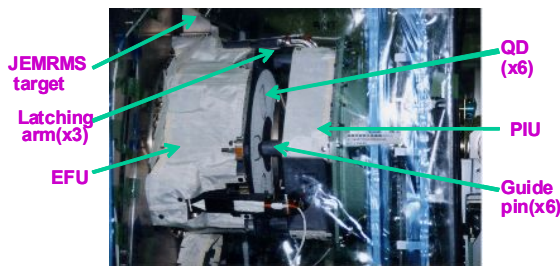

Fig.4 Experimental Exchange Unit (EEU)

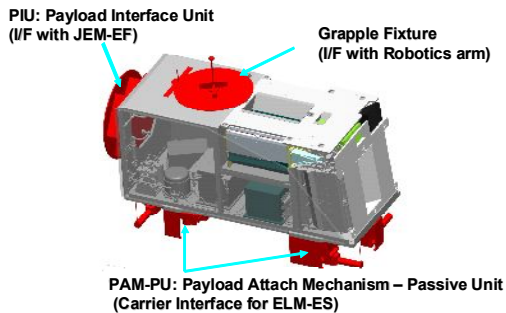

Fig.5 JEM-EP Interface on payload

5. Launch Configuration

The JEM-EP payload will be launched by the Space Shuttle or HTV. MAXI will be launched by the Space Shuttle (STS-127) along with JEM-EP and other equipment. However, after the Shuttle retirement, only the HTV-EP will be a transportation carrier. Fig. 6 shows the HTV-EP with attached payloads. The interface with the HTV-EP is different from the ELM-ES interface, which is called HTV Cargo Attachment Mechanism (HCAM).

HTV-EP will be used for the payload disposal (by de-orbit re-entry burn) after the mission. Currently there is no capability to retrieve the payload after the Shuttle retirement.

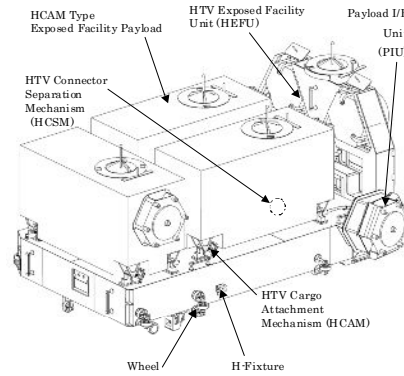

Fig. 6 HTV-EP interface



Fig. 7 MAXI (right) on the Shuttle carrier (ELM-ES)

6. References

K.Kawasaki, M.Matsuoka, et al, 56th IAC, 2005, IAC-05-B5.2.06Y